

Option 18 ガイド

搬送物、搬送、条件に合わせてガイドも選定できます。

■34フレーム用ガイド

3G-TL型 (スチール製) / 固定式

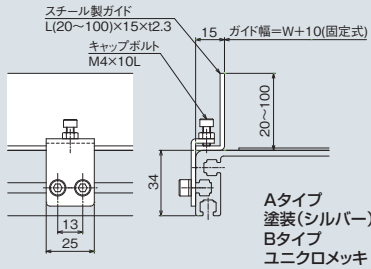

3G-AL型 (アルミ製) / 固定式

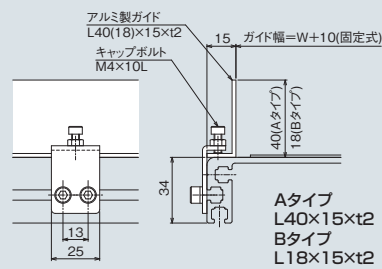

3G-SL型 (ステンレス製) / 固定式

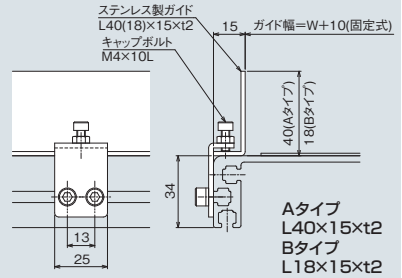

3G-SO-1型 (ステンレス製) / 幅調整式

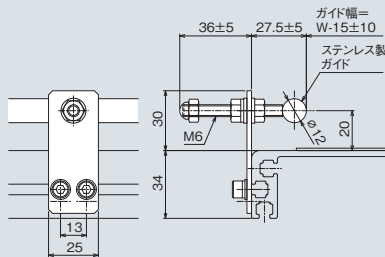

3G-SO-2型 (ステンレス製) / 高さ幅調整式

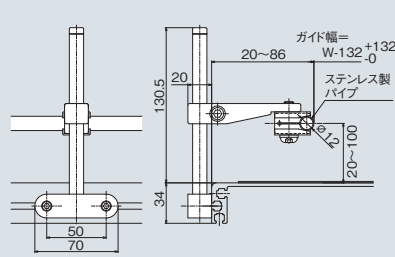

3G-SO-3型 (ステンレス製) / 固定式

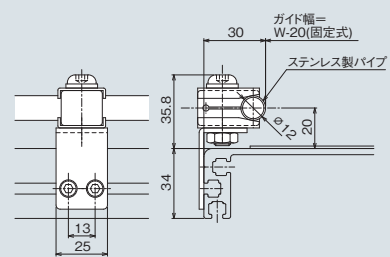

3G-JO型 (樹脂製) / 幅調整式

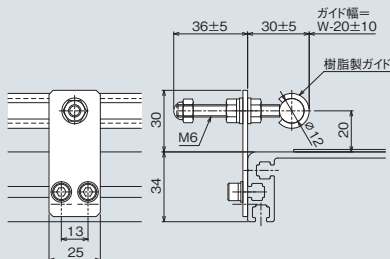

3G-SF型 (ステンレス製) / 幅調整式

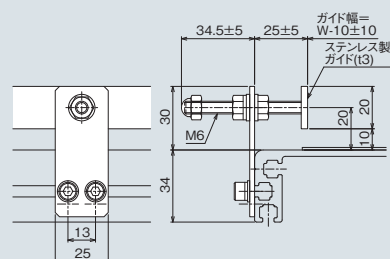

3G-A1型 (アルミ製) / 幅調整式

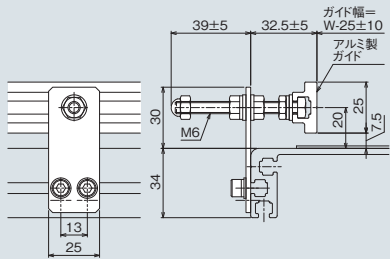

3G-J1型 (樹脂製) / 幅調整式

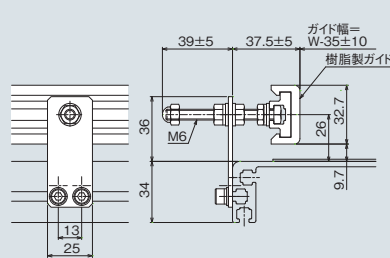

3G-U1型 (樹脂製スカート付) / 幅調整式

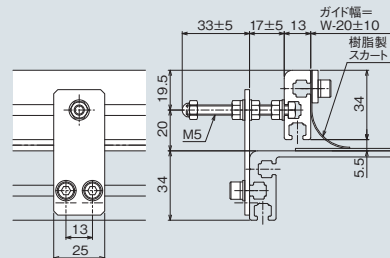

3G-U2 (3G-JU) 型

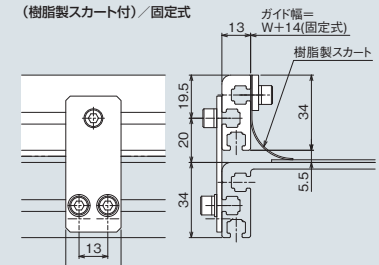

Option 19 ガイド

搬送物、搬送、条件に合わせてガイドも選定できます。

■40フレーム用ガイド

4G-TL型 (スチール製) / 固定式

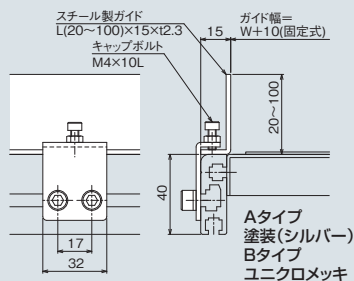

4G-AL型 (アルミ製) / 固定式

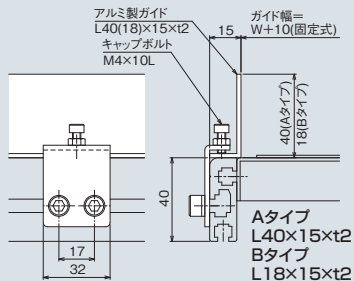

4G-SL型 (ステンレス製) / 固定式

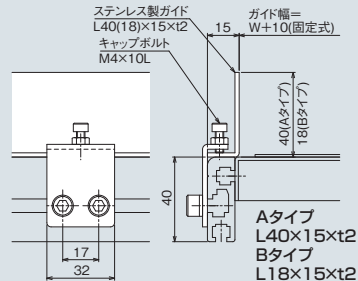

4G-SO型 (ステンレス製) / 幅調整式

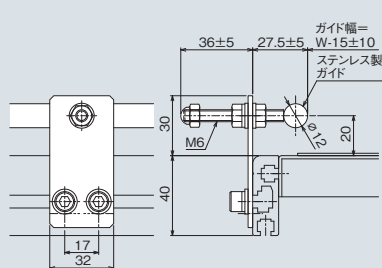

4G-JO型 (樹脂製) / 幅調整式

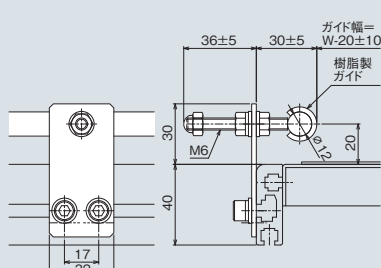

4G-SF型 (ステンレス製) / 幅調整式

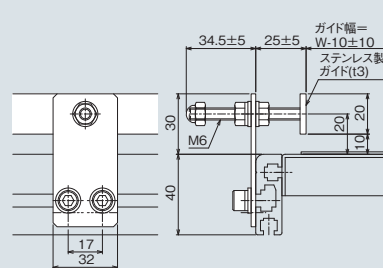

4G-A1型 (アルミ製) / 幅調整式

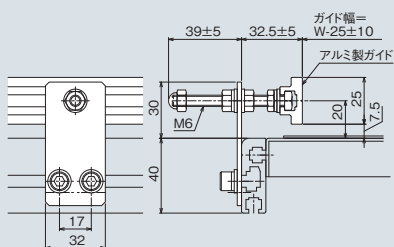

4G-J1型 (樹脂製) / 幅調整式

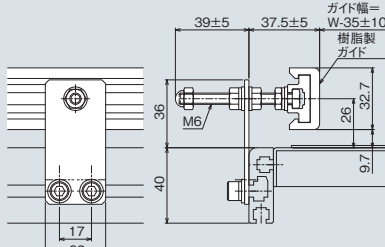

4G-U1 (4G-JU) 型

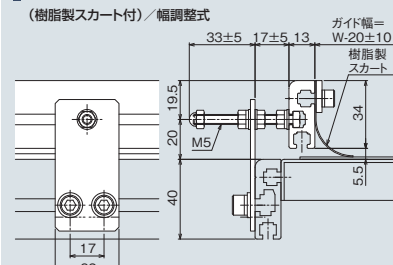

Option 20 ガイド

搬送物、搬送、条件に合わせてガイドも選定できます。

■60フレーム用ガイド

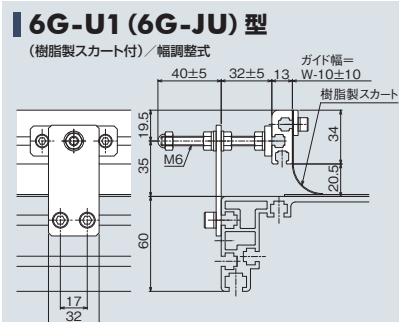
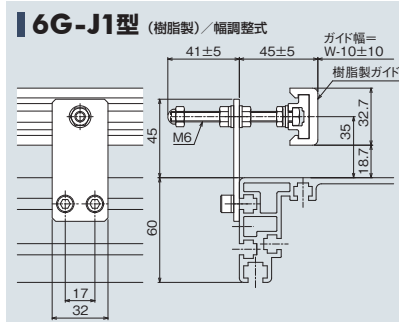
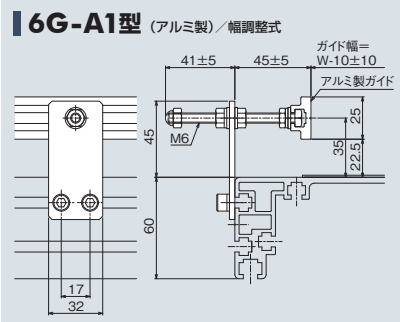
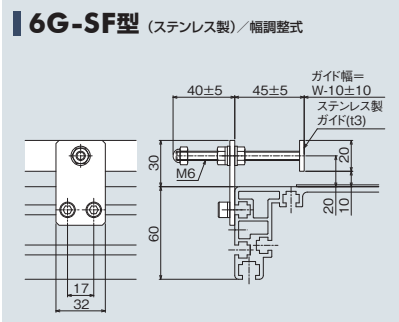
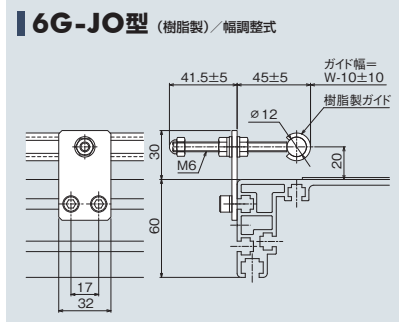
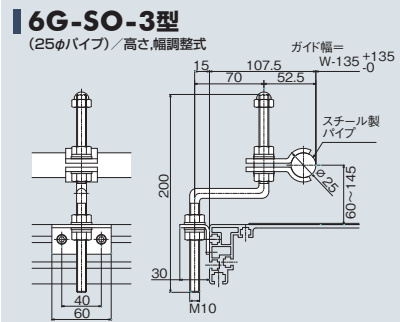
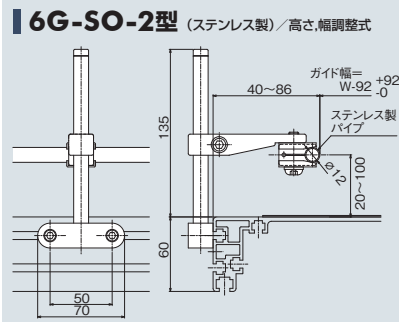
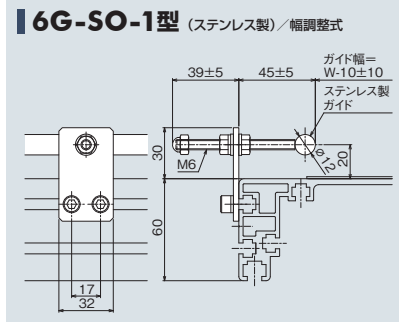
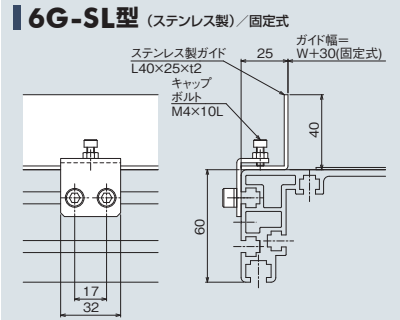
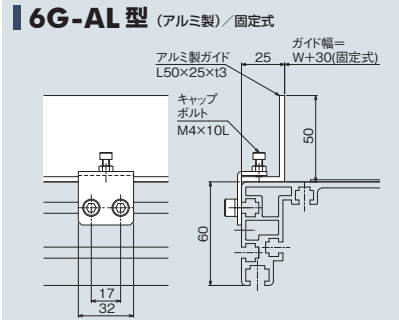
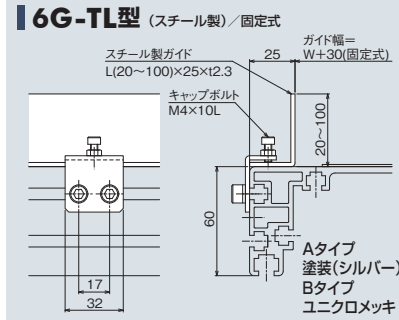

Option 21 ガイド

搬送物、搬送、条件に合わせてガイドも選定できます。

■90フレーム用ガイド

