



### みぞぶた(側溝用)

材質:SS400

普通目:30P(35.3P)

表面:ノンスリップ

主部材:Iバー



#### 型式記号の説明

みぞぶた 主部材(I-50×7×4) みぞ幅を表示(300mm)

# NM 50N-3

ノンスリップを表示

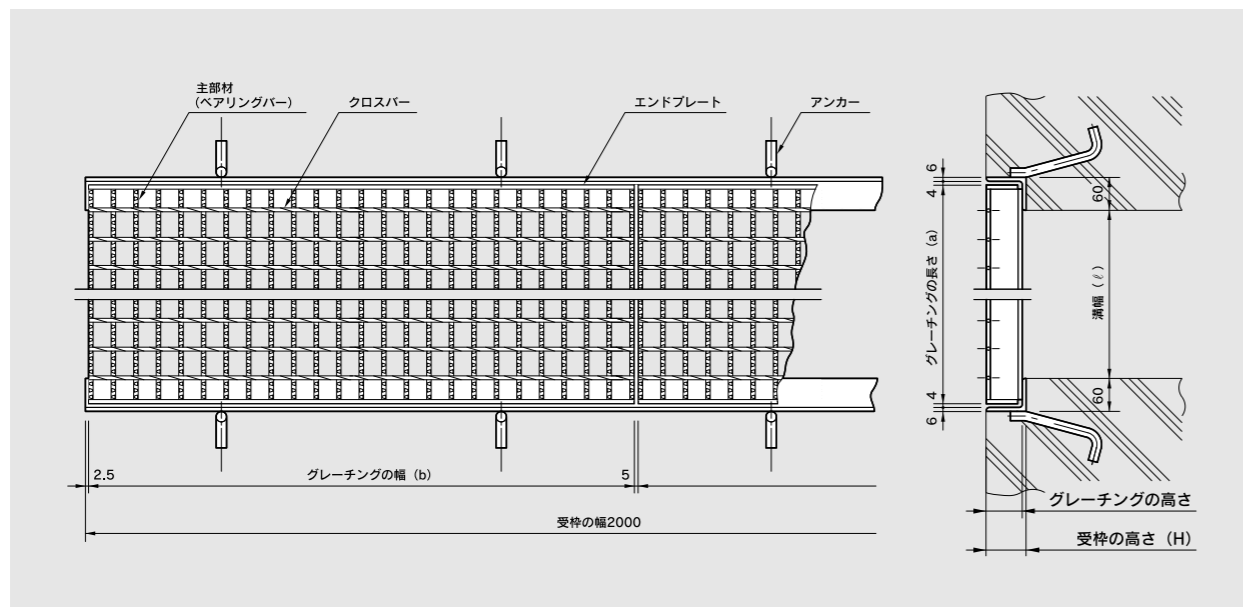
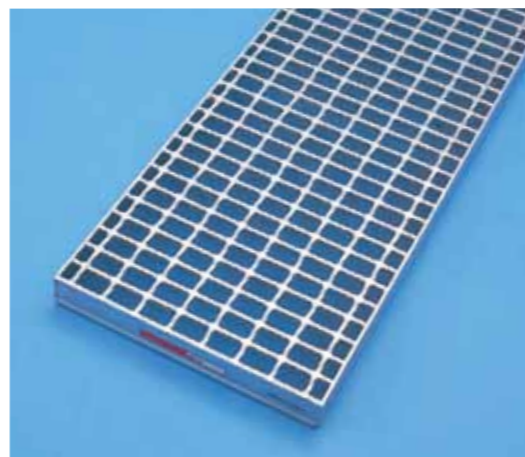

## T-25



溝幅 (ℓ) mm	型式記号	グレーチング			受 枠		総質量 kg/枚	建 値						
		寸 法 mm			質量 kg/枚	寸 法 mm		質量 kg/枚	標準価格			北海道・沖縄		
		長さ(a)	幅(b)	主部材					本体	受枠	合計	本体	受枠	合計
200	NM38N-2	300	995	I-38	15.1	L44x60x6	9.8	24.9	11,400	6,600	18,000	12,000	7,000	19,000
250	NM44N-2.5	350	995	I-44	19.8	L50x60x6	10.4	30.2	14,100	7,000	21,100	14,900	7,400	22,300
300	NM50N-3	400	995	I-50	27.8	L56x60x6	11.2	39.0	20,000	7,400	27,400	21,000	7,800	28,800
350	NM55N-3.5	450	995	I-55	33.6	L61x60x6	11.6	45.2	24,400	7,600	32,000	25,700	8,000	33,700
400	NM65N-4	500	995	I-65	43.3	L71x60x6	12.5	55.8	31,800	8,000	39,800	33,400	8,400	41,800
450	NM75N-4.5	550	995	I-75	54.1	L81x60x6	13.4	67.5	39,800	8,200	48,000	41,800	8,600	50,400
500	NM90N-5	600	995	I-90	69.0	PL96x60x6	14.8	83.8	56,700	9,600	66,300	59,000	10,000	69,000
550	NM90N-5.5	650	995	I-90	74.4	PL96x60x6	14.8	89.2	66,200	9,600	75,800	69,600	10,000	79,600
600	NM100N-6	700	995	I-100	87.9	PL106x60x6	15.7	103.6	78,900	9,800	88,700	82,900	10,200	93,100

●1件につき5万円以下のご注文については小口運賃として別途2,000円を申し受けます。 ●本価格表は消費税を含んでおりません。



### みぞぶた(側溝用)

## T-20



溝幅 (ℓ) mm	型式記号	グレーチング			受 枠		総質量 kg/枚	建 値						
		寸 法 mm			質量 kg/枚	寸 法 mm		質量 kg/枚	標準価格			北海道・沖縄		
		長さ(a)	幅(b)	主部材					本体	受枠	合計	本体	受枠	合計
200	NM32N-2	300	995	I-32	13.0	L38x60x6	9.3	22.3	10,400	5,800	16,200	10,900	6,100	17,000
250	NM38N-2.5	350	995	I-38	17.3	L44x60x6	9.8	27.1	13,000	6,600	19,600	13,700	7,000	20,700
300	NM50N-3	400	995	I-50	27.8	L56x60x6	11.2	39.0	20,000	7,400	27,400	21,000	7,800	28,800
350	NM50N-3.5	450	995	I-50	30.9	L56x60x6	11.2	42.1	21,800	7,400	29,200	22,900	7,800	30,700
400	NM55N-4	500	995	I-55	37.0	L61x60x6	11.6	48.6	26,600	7,600	34,200	28,000	8,000	36,000
400	NM60N-4	500	995	I-60	40.7	L66x60x6	12.0	52.7	28,200	7,700	35,900	29,600	8,200	37,800
450	NM65N-4.5	550	995	I-65	47.3	L71x60x6	12.5	59.8	32,600	8,000	40,600	34,300	8,400	42,700
500	NM75N-5	600	995	I-75	58.7	L81x60x6	13.4	72.1	41,000	8,200	49,200	43,100	8,600	51,700
550	NM75N-5.5	650	995	I-75	63.3	L81x60x6	13.4	76.7	43,500	8,200	51,700	45,700	8,600	54,300
550	NM90N-5.5	650	995	I-90	74.4	PL96x60x6	14.8	89.2	66,200	9,600	75,800	69,600	10,000	79,600
600	NM90N-6	700	995	I-90	79.7	PL96x60x6	14.8	94.5	67,900	9,600	77,500	71,300	10,000	81,300
700	NM100N-7	800	995	I-100	99.9	PL106x60x6	15.7	115.6	79,600	9,700	89,300	83,400	10,200	93,600

## T-14



溝幅 (ℓ) mm	型式記号	グレーチング			受 枠		総質量 kg/枚	建 値						
		寸 法 mm			質量 kg/枚	寸 法 mm		質量 kg/枚	標準価格			北海道・沖縄		
		長さ(a)	幅(b)	主部材					本体	受枠	合計	本体	受枠	合計
200	NM25N-2	300	995	I-25	10.4	L31x60x6	8.2	18.6	9,200	5,600	14,800	9,700	5,800	15,500
250	NM32N-2.5	350	995	I-32	14.9	L38x60x6	9.3	24.2	10,900	5,800	16,700	11,500	6,100	17,600
300	NM38N-3	400	995	I-38	19.5	L44x60x6	9.8	29.3	13,800	6,600	20,400	14,600	7,000	21,600
350	NM44N-3.5	450	995	I-44	24.7	L50x60x6	10.4	35.1	17,100	6,900	24,000	18,000	7,200	25,200
400	NM50N-4	500	995	I-50	34.1	L56x60x6	11.2	45.3	23,700	7,400	31,100	24,900	7,800	32,700
450	NM55N-4.5	550	995	I-55	40.5	L61x60x6	11.6	52.1	29,100	7,600	36,700	30,600	8,000	38,600
500	NM60N-5	600	995	I-60	48.2	L66x60x6	12.0	60.2	33,600	7,800	41,400	35,300	8,200	43,500
550	NM65N-5.5	650	995	I-65	55.3	L71x60x6	12.5	67.8	38,100	8,000	46,100	40,100	8,400	48,500
600	NM75N-6	700	995	I-75	67.8	L81x60x6	13.4	81.2	46,900	8,200	55,100	49,300	8,600	57,900
700	NM90N-7	800	995	I-90	90.5	PL96x60x6	14.8	105.3	75,300	9,600	84,900	78,800	10,000	88,800

## T-6



溝幅 (ℓ) mm	型式記号	グレーチング			受 枠		総質量 kg/枚	建 値						
		寸 法 mm			質量 kg/枚	寸 法 mm		質量 kg/枚	標準価格			北海道・沖縄		
		長さ(a)	幅(b)	主部材					本体	受枠	合計	本体	受枠	合計
200	NM25N-2	300	995	I-25	10.4	L31x60x6	8.2	18.6	9,200	5,600	14,800	9,700	5,800	15,500
250	NM32N-2.5	350	995	I-32	14.9	L38x60x6	9.3	24.2	10,900	5,800	16,700	11,500	6,000	17,500
300	NM38N-3	400	995	I-38	19.5	L44x60x6	9.8	29.3	13,800	6,600	20,400	14,500	7,000	21,500
350	NM44N-3.5	450	995	I-44	24.7	L50x60x6	10.4	35.1	17,100	7,000	24,100	18,000	7,400	25,400
400	NM44N-4	500	995	I-44	27.2	L50x60x6	10.4	37.6	18,600	7,000	25,600	19,600	7,400	27,000
450	NM50N-4.5	550	995	I-50	37.3	L56x60x6	11.2	48.5	26,000	7,400	33,400	27,300	7,800	35,100
500	NM50N-5	600	995	I-50	40.4	L56x60x6	11.2	51.6	28,200	7,400	35,600	29,700	7,800	37,500
550	NM50N-5.5	650	995	I-50	43.6	L56x60x6	11.2	54.8	30,200	7,400	37,600	31,800	7,800	39,600
600	NM55N-6	700	995	I-55	50.7	L61x60x6	11.6	62.3	35,000	7,600	42,600	36,800	8,000	44,800
700	NM60N-7	800	995	I-60	63.2	L66x60x6	12.0	75.2	44,400	7,800	52,200	46,600	8,200	54,800

●1件につき5万円以下のご注文については小口運賃として別途2,000円を申し受けます。 ●本価格表は消費税を含んでおりません。



### みぞぶた(側溝用)



### みぞぶた(横断溝用)

## T-2

溝幅 (ℓ) mm	型式記号	グレーチング			重量 kg/枚	受 枠			総重量 kg/枚	建 値						
		寸 法 mm				重量 kg/枚	寸 法 mm			標準価格			北海道・沖縄			
		長さ(a)	幅(b)	主部材			重量 kg/枚	本体		受枠	合計	本体	受枠	合計		
200	NM25N-2	300	995	I-25	10.4	L31x60x6	8.2	18.6	9,200	5,600	14,800	9,700	5,800	15,500		
250	NM25N-2.5	350	995	I-25	11.9	L31x60x6	8.2	20.1	10,100	5,600	15,700	10,700	5,800	16,500		
300	NM25N-3	400	995	I-25	13.5	L31x60x6	8.2	21.7	10,900	5,600	16,500	11,500	5,800	17,300		
350	NM25N-3.5	450	995	I-25	15.0	L31x60x6	8.2	23.2	11,600	5,600	17,200	12,200	5,800	18,000		
400	NM32N-4	500	995	I-32	20.6	L38x60x6	9.3	29.9	14,500	5,800	20,300	15,300	6,000	21,300		
450	NM32N-4.5	550	995	I-32	22.5	L38x60x6	9.3	31.8	15,200	5,800	21,000	16,000	6,000	22,000		
500	NM32N-5	600	995	I-32	24.5	L38x60x6	9.3	33.8	16,200	5,800	22,000	17,100	6,000	23,100		
550	NM32N-5.5	650	995	I-32	26.4	L38x60x6	9.3	35.7	17,300	5,800	23,100	18,200	6,000	24,200		
600	NM38N-6	700	995	I-38	32.6	L44x60x6	9.8	42.4	22,200	6,600	28,800	23,400	7,000	30,400		
700	NM38N-7	800	995	I-38	37.1	L44x60x6	9.8	46.9	25,200	6,600	31,800	26,400	7,000	33,400		

### ●細目用把手HN-2 (垂鉛メッキ)

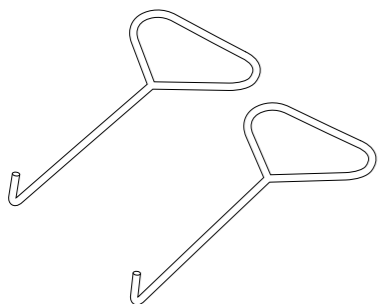

価 格	1,000円/本
-----	----------

### ●Nクリップ(連結クリップ)

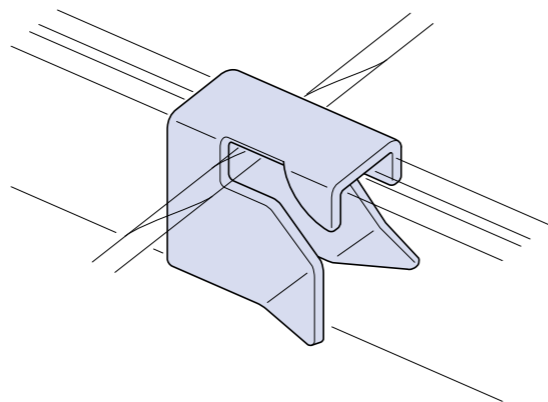

	価 格
NC-1 主部材厚み(3mm用)	500円/個
NC-2 主部材厚み(4.5mm・5mm用)	
NC-3 主部材厚み(7mm用)	

### ●Lシート

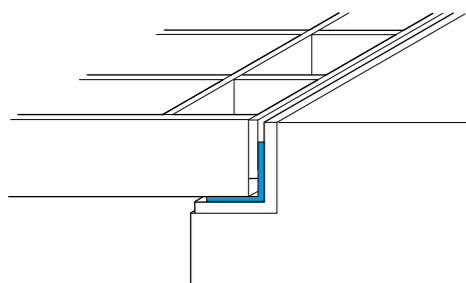

	価 格
GL-1 19x50x2x998	1,600円/2枚

●1件につき5万円以下のご注文については小口運賃として別途2,000円を申し受けます。 ●本価格表は消費税を含んでおりません。

材質:SS400 普通目:30P(35.3P) 表面:ノンスリップ 主部材:Iバー



### 型式記号の説明

みぞぶた 主部材(I-50x7x4) みぞ幅を表示(300mm)  
**NM 50N-3**  
 ノンスリップを表示

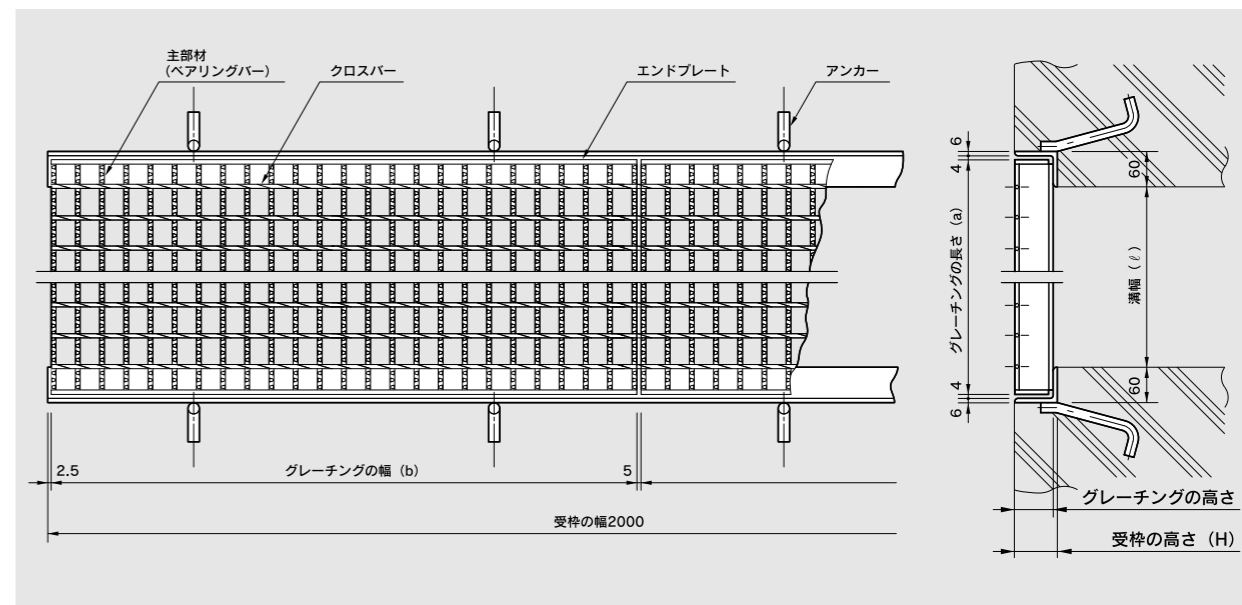
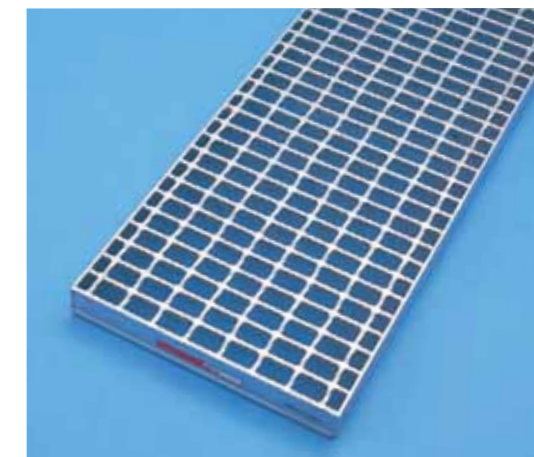

## T-25

溝幅 (ℓ) mm	型式記号	グレーチング			質量 kg/枚	受 枠			総質量 kg/枚	建 値						
		寸 法 mm				重量 kg/枚	寸 法 mm			標準価格			北海道・沖縄			
		長さ(a)	幅(b)	主部材			重量 kg/枚	本体		受枠	合計	本体	受枠	合計		
200	NM44N-2	300	995	I-44	17.3	L50x60x6	10.4	27.7	12,700	7,000	19,700	13,400	7,400	20,800		
250	NM50N-2.5	350	995	I-50	24.7	L56x60x6	11.2	35.9	18,100	7,400	25,500	19,100	7,800	26,900		
300	NM55N-3	400	995	I-55	30.3	L61x60x6	11.6	41.9	22,500	7,600	30,100	23,700	8,000	31,700		
350	NM60N-3.5	450	995	I-60	37.0	L66x60x6	12.0	49.0	27,200	7,800	35,000	28,600	8,200	36,800		
400	NM65N-4	500	995	I-65	43.3	L71x60x6	12.5	55.8	31,800	8,000	39,800	33,400	8,400	41,800		
450	NM75N-4.5	550	995	I-75	54.1	L81x60x6	13.4	67.5	39,800	8,200	48,000	41,800	8,600	50,400		
500	NM75N-5	600	995	I-75	58.7	L81x60x6	13.4	72.1	41,000	8,200	49,200	43,100	8,600	51,700		
550	NM90N-5.5	650	995	I-90	74.4	PL96x60x6	14.8	89.2	66,200	9,600	75,800	69,600	10,000	79,600		
600	NM90N-6	700	995	I-90	79.7	PL96x60x6	14.8	94.5	67,900	9,600	77,500	71,300	10,000	81,300		
700	NM100N-7	800	995	I-100	99.9	PL106x60x6	15.7	115.6	79,600	9,800	89,400	83,400	10,200	93,600		

●1件につき5万円以下のご注文については小口運賃として別途2,000円を申し受けます。 ●本価格表は消費税を含んでおりません。